



Issue	January 4, 2025
Rev.	1.0
Page	5

CRYSTAL UNIT SPECIFICATIONS

客户批准 Customer Approval

(请批准后回签一份 **Please Return A Copy With Approval**)

Customer	
Customer P/N	
Product	CRYSTAL RESONATORS
Spec	PMX406/7.3728~90.000MHz
A-Crystal P/N	AM5 Series

Drawn	Checked	Approved
<i>Caoqiaobang</i>	<i>Fengying</i>	<i>Tanqlong</i>



ZHEJIANG A-CRYSTAL

ELECTRONIC TECHNOLOGY CO., LTD.



1. ELECTRICAL SPECIFICATIONS

1.1 Hold Type: PMX-406

No.	Item	Symb	Electrical Specification				Remark
			Min.	Type	Max.	Units	
1	Nominal Frequency	F0	7.3728		90.00	MHz	
2	Mode of Vibration		■ Fundamental △3rd Overtone △5th Overtone				
3	Frequency Tolerance	$\Delta F/F0$	± 10	± 30	± 50	ppm	at 25°C±3°C
4	Operating Temperature Range	T _{OPR}	-20 -40	-	+70 +85	°C	
5	Frequency Stability	T _C	± 30	-	± 50	ppm	
6	Storage Temperature	T _{STG}	-55	-	+125	°C	
7	Load capacitance	CL	6~specify			pF	
8	Equivalent Series Resistance	ESR	Seepage 1			Ω	
9	Drive Level	DL	-	100	200	μW	
10	Insulation Resistance	IR	500	-	-	MΩ	At 100V _{DC}
11	Shunt Capacitance	Co	-	-	5	pF	
12	Aging Per Year	Fa	-5	-	+5	ppm	First Year
13	Package type	10.4*4.06*3.6					

Seepage1

Frequency Range	Mode	ESR (Ω)	Frequency Range	Mode	ESR (Ω)
7.3728MHz≤F0≤10.0MHz	Fund	100 Max	16.10MHz≤F0≤20.0MHz	Fund	40 Max
10.100MHz≤F0≤12.0MHz	Fund	80 Max	20.100MHz≤F0≤64.0MHz	Fund	30 Max
12.100MHz≤F0≤13.0MHz	Fund	60 Max	30.100MHz≤F0≤90.0MHz	3rd	100 Max
13.100MHz≤F0≤16.0MHz	Fund	50 Max			

注: ROHS 豁免 ROHS exemption, 高温高铅 high lead and high temperature;



1.2 Dimension (Unit: mm)

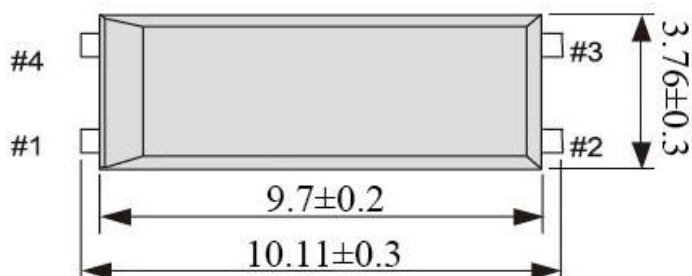

Note: Metal may be exposed on the top or bottom of this product this will not affect any quality reliability or electrical spec

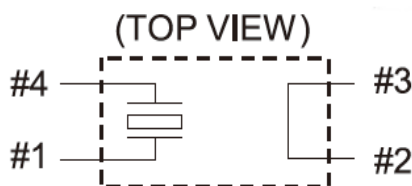
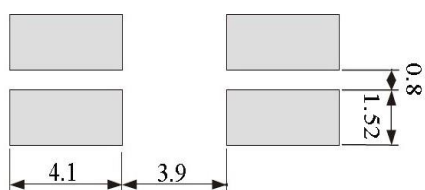
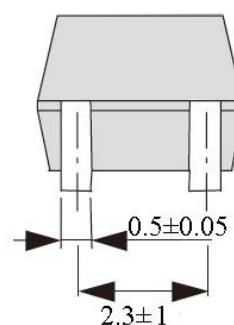
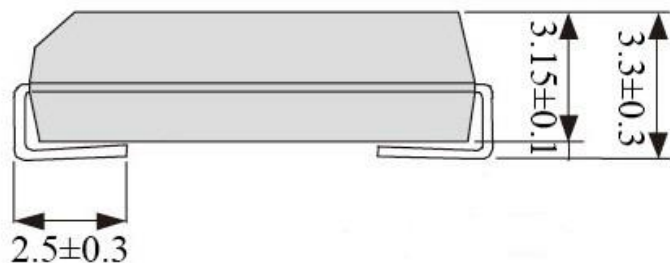

1.3 Marking

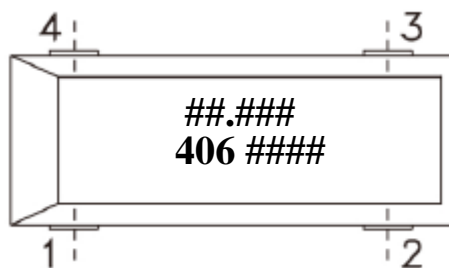



1.4 Reflow solder

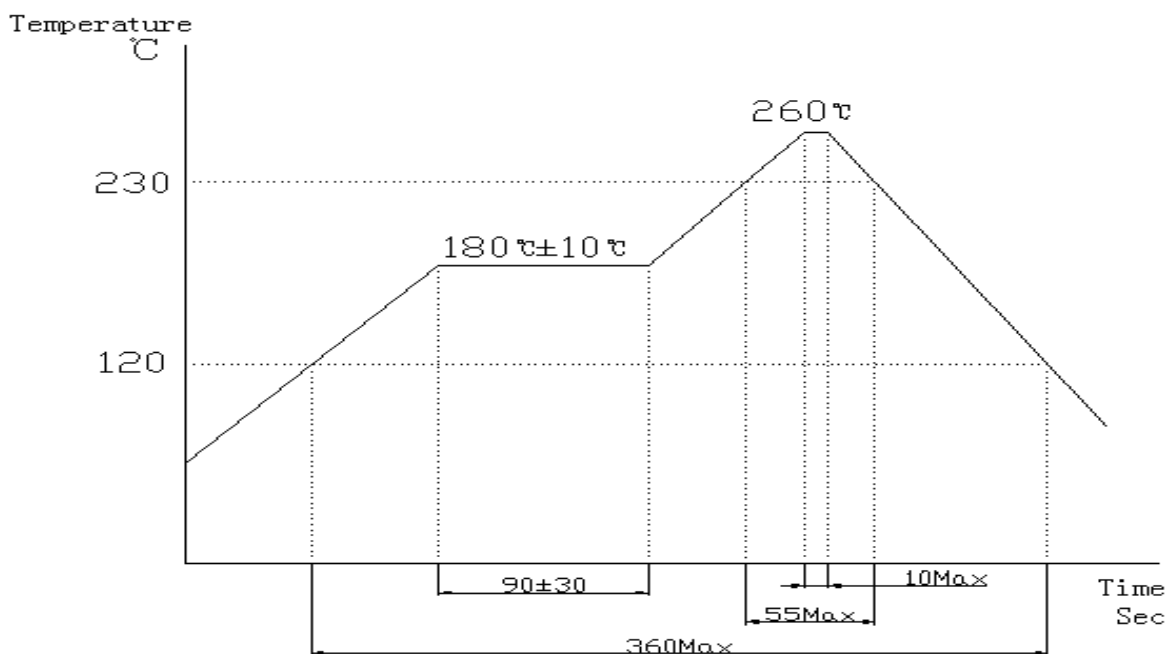

2. Packing

2.1 Packing Method Sketch Map (Unit: mm)

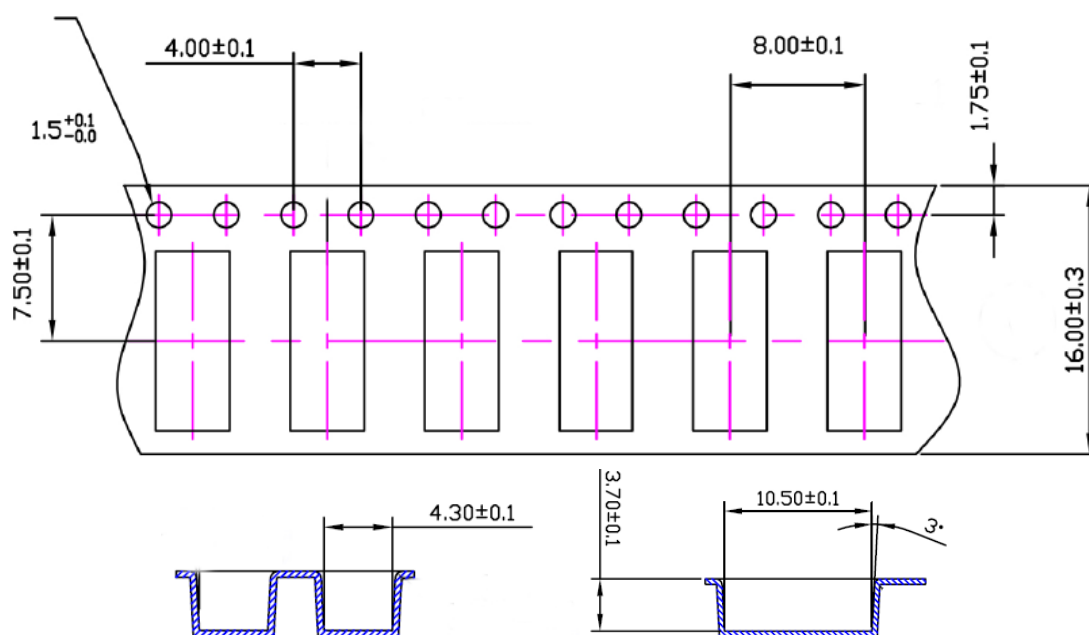



2.2 Reel Dimensions (Unit: mm)

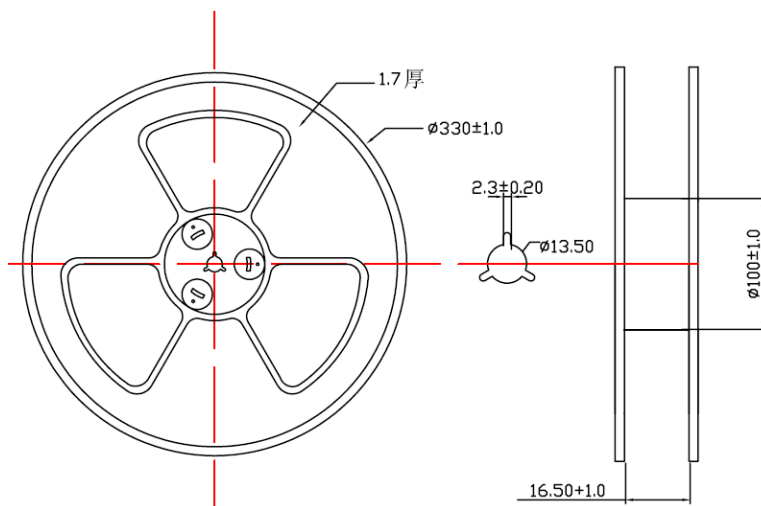

Pieces per reel: 2000/reel

3. Products Code

3.1 SMD Crystal Resonators/MHz

公司代码 浙江一晶	产品型号 (2位)	工作频率 (全频点位数)	负载电容 (1位字母)	调整频差 (1位字母)	温度频差 (1位字母)	工作温度 (1位字母)	其它
A-crystal Logo	Package	Nominal Frequency	Load Capacitance	Frequency Tolerating	Freq Temp Characteristics	Operating Temperature Range	Others
A	M5 (PMX406)	8.000M	无穷大=000	01=5PPM	T=-0.034± 0.006ppm/(°C) ²	1=0~50	Special
		12.000M	9PF=009	02=10PPM	A=10PPM	2=-10~60	
			12PF=012	03=20PPM	B=15PPM	3=-10~70	
			12.5PF=125	04=30PPM	C=20PPM	4=-20~70	
				05=40PPM	D=25PPM	5=-30~85	
				06=50PPM	E=30PPM	6=-40~85	
					F=50PPM	7=-40~105	
						8=-40~125	