



ZHEJIANG A-CRYSTAL

ELECTRONIC TECHNOLOGY CO., LTD.



Issue	June 13, 2023
Rev.	1.0
Page	9

## CRYSTAL UNIT SPECIFICATIONS

客户批准 Customer Approval

(请批准后回签一份 Please Return A Copy With Approval)

Customer	
Customer P/N	
Product	CRYSTAL RESONATORS
Spec	PMX406/25.600~307.20KHz
A-Crystal P/N	AM5 Series

Drawn	Checked	Approved
<i>caogaobang</i>	<i>tanglong</i>	<i>huangweilong</i>



**ZHEJIANG A-CRYSTAL**  
**ELECTRONIC TECHNOLOGY CO., LTD.**



## 1. ELECTRICAL SPECIFICATIONS

### 1.1 Hold Type: PMX-406

Parameter	Symb	Electrical Specification				Condition
		Min	Type	Max	Units	
Frequency Range	F <sub>0</sub>	25.60	32.768	307.20	KHz	
Frequency Tolerance	$\Delta f/f_0$	$\pm 5$	$\pm 20$	$\pm 100$	PPM	REF TO 25°C
Temperature Coefficient	K	-0.034 $\pm$ 0.006			ppm/(°C) <sup>2</sup>	
Turnover Temperature	T <sub>TO</sub>	20	25	30	°C	
Operating Temperature Range	T <sub>OP</sub>	-20 -40		+70 +85	°C	
Storage Temperature Range	T <sub>ST</sub>	-55		125	°C	
Quality Factor	Q	60,000			Typ	
Series Resistance	R <sub>1</sub>	35		50	K $\Omega$	REF TO 25°C
Shunt Capacitance	C <sub>0</sub>	0.9	1.9	2.0	Typ	0.9~2.0PF
Motional Capacitance	C <sub>1</sub>		2.7		Ff TYP	
Load Capacitance	C <sub>L</sub>	6	12.5	30	PF	
Insulator Resistance	IR	500			M $\Omega$	DC100V $\pm$ 15V
Drive Level	DL			1.0	$\mu$ W	
Capacitance ratio	R		450		TYP	
Aging Rate	$\Delta/f$	$\pm 3$		$\pm 5$	PPM	at 25°C $\pm$ 3°C
Moist are Sensitivity Level	MSL		1			J-STD-033
Package type	10.4*4.06*3.6					

注: ROHS 豁免 ROHS exemption, 高温高铅 high lead and high temperature;



1.2 Dimension (Unit: mm)

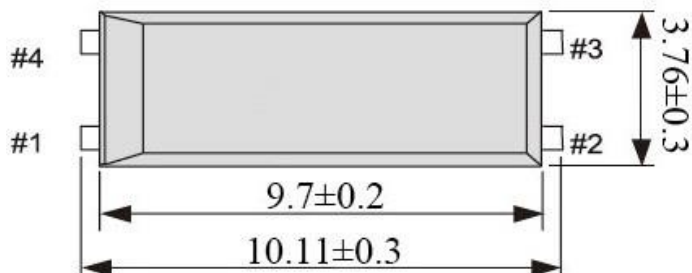

**Note:** Metal may be exposed on the top or bottom of this product this will not affect any quality reliability or electrical spec

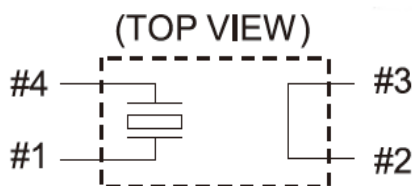
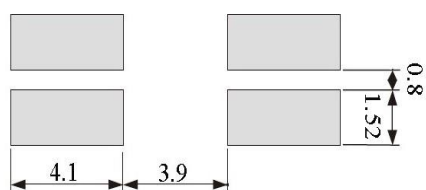
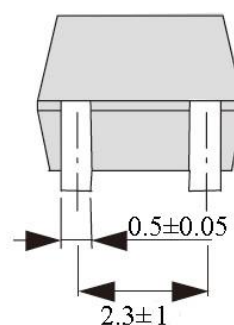
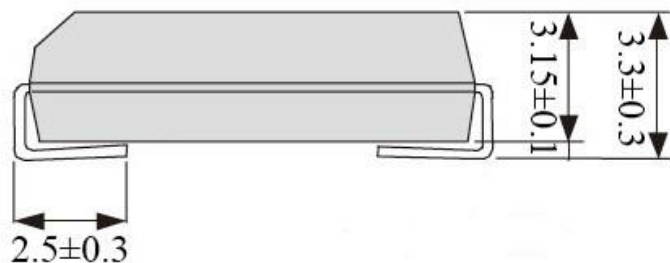

1.3 Marking

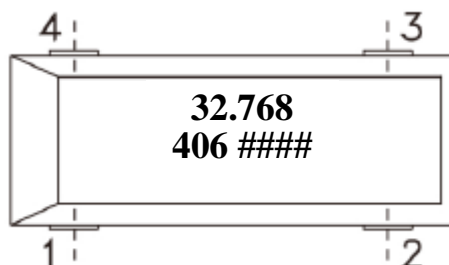



### 1.4 Reflow solder

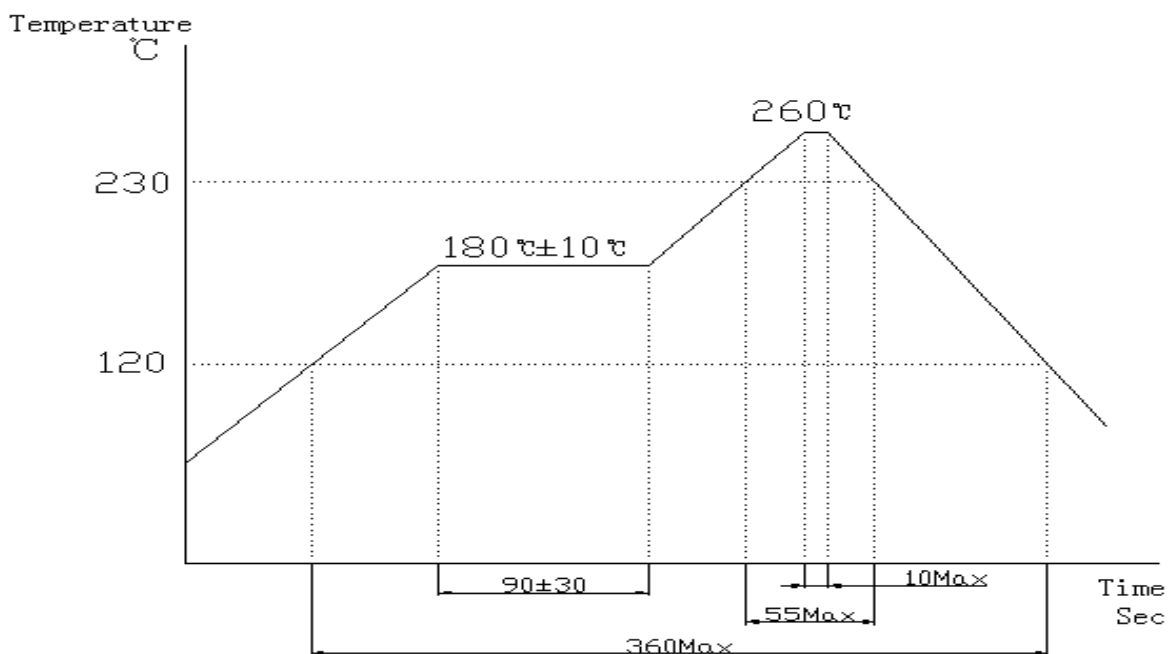

## 2. Packing

### 2.1 Packing Method Sketch Map (Unit: mm)

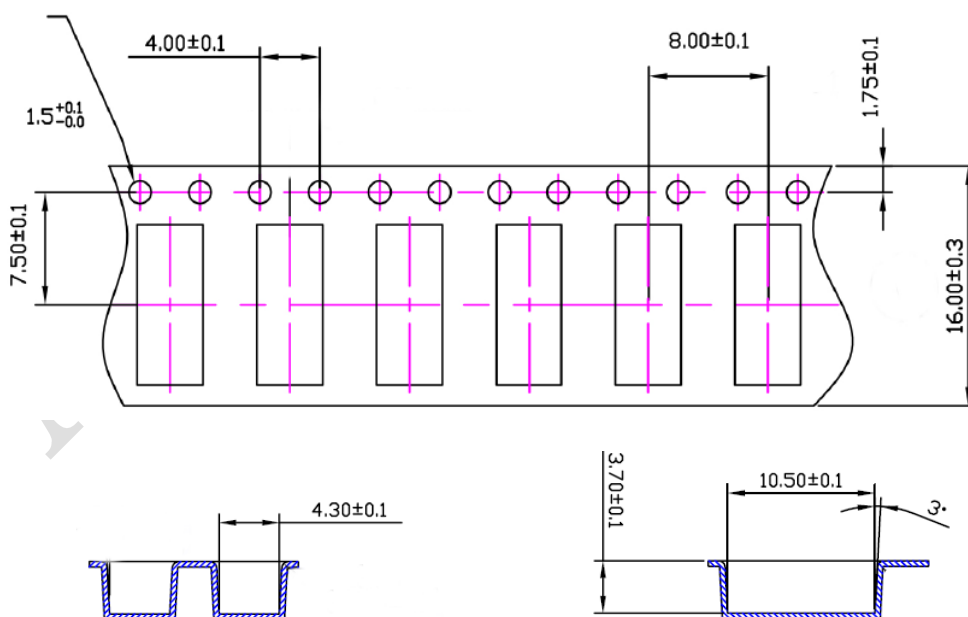



**ZHEJIANG A-CRYSTAL**  
**ELECTRONIC TECHNOLOGY CO., LTD.**



## 2.2 Reel Dimensions (Unit: mm)

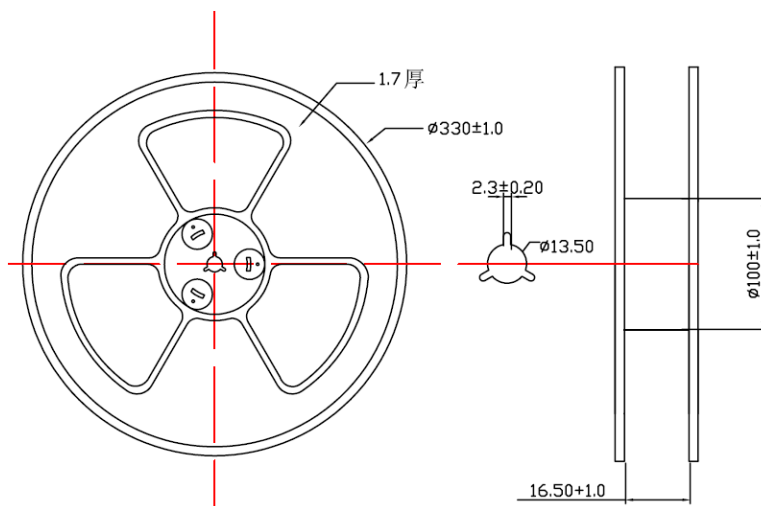

Pieces per reel: 2000/reel

## 3. Products Code

### 3.1 SMD Crystal Resonators/KHz

公司代码 浙江一晶	产品型号 (2位)	工作频率 (全频点位数)	负载电容 (1位字母)	调整频差 (1位字母)	温度频差 (1位字母)	工作温度 (1位字母)	其它
A-crystal Logo	Package	Nominal Frequency	Load Capacitance	Frequency Tolerating	Freq Temp Characteristics	Operating Temperature Range	Others
A	M5 (PMX406)	32.768K	A = 12.5PF	A=10PPM	T = 温度系数	A = 0~50	Special
		40.000K	B = 10PF	B=20PPM		B = -10~60	
			C = 9PF	C=30PPM		C = -10~70	
			D = 8PF	D=50PPM		D = -20~70	
			E = 7PF			E = -30~85	
			F = 6PF			F = -40~85	
			G = 16PF			G = -40~105	
			H = 18PF			H = -40~125	
			J = 20PF				
			K = 22PF				
			L = 30PF				